

www.solarspot.co.za

— *Where sun shined*
Power always on —



USER MANUAL

Off Grid Solar Inverter

SNA3000 WPV

SNA4000 WPV

SNA5000 WPV



Monitor APP Download



Android



IOS

Table Of Contents

Information on this Manual	01	3. Working Modes	15
Validity	01	3.1 Offgrid modes introduction	15
Scope	01	3.2 Working modes related setting description	17
Target Group	01	4. LCD Display and settings	21
Safety Instructions	01	4.1 LED Display	21
1. Brief Introduction	02	4.2 LCD Display	21
1.1 Features of the inverter	02	4.3 Inverter Status Display	23
1.2 Interface of the inverter	03	4.4 LCD Settings	24
1.3 Packing list	04	5. Monitor System for Offgrid	31
2. Installation	05	6. Specifications	32
2.1 Preparation	05	7. Trouble Shooting & Error List	35
2.2 Mounting the Unit	07		
2.3 Battery Connection	08		
2.3.1 Battery Power Cable Connection	08		
2.3.2 Lithium Battery Connection	08		
2.4 AC Input/Output Connection	09		
2.5 PV Connection	10		
2.6 Generator Connection	10		
2.7 Dry Contact Signal control	12		
2.8 Parallel function	12		
2.9 Power ON/OFF	14		

Information on this Manual

Validity

This manual is valid for the following devices: SNA3000 WPV/SNA4000 WPV/SNA5000 WPV

Scope

This manual provides the installation, operation and troubleshooting of this unit, please read this manual carefully before installations and operations.

Target Group

For qualified persons and end users. Qualified persons and end users must have the following skills:

- Knowledge about this unit operation
- Training in deal with the security issues associated with installations and electrical safety
- Training in the installation and commissioning of electrical devices and installations
- Knowledge of the applicable local standards and directives

Safety Instructions

WARNING: This chapter contains important safety and operating instructions. Read and keep this manual for future reference.

- All the operation and connection need to be operated by qualified persons.
- Before using the unit, read all instructions and cautionary marking on the unit. Any damage caused by inappropriate operation is not warranted by Luxpower .
- All the electrical installation must comply with the local electrical safety standards.
- Do not disassemble the unit. Take it to a qualified service center when service or repair is required, incorrect re-assembly may result in a risk of electric shock or fire. Do not open inverter cover or change any components without Luxpower's authorization, otherwise the warranty commitment for the inverter will be invalid.
- To reduce risk of electric shock, disconnect all wirings before attempting any maintenance or cleaning, turning off the unit will not reduce this risk.
- **CAUTION-**To reduce risk of injury, charge only deep-cycle lead-acid type rechargeable batteries and lithium batteries, other types of batteries may burst, causing personal injury and damage.
- NEVER charge a frozen battery.
- For optimum operation of this unit, please follow required spec to select appropriate cable size and breaker.
- Please strictly follow installation procedure when you want to disconnect AC or DC terminals, please refer to **INSTALLATION** section of this manual for the details.
- **GROUNDING INSTRUCTIONS** - This unit should be connected to a permanent grounded wiring system, be sure to comply with local requirements and regulation to install this inverter.
- NEVER cause AC output and DC input short circuited. Do not connect to the mains when DC input short circuits.

1. Brief Introduction

1.1 Features of the inverter

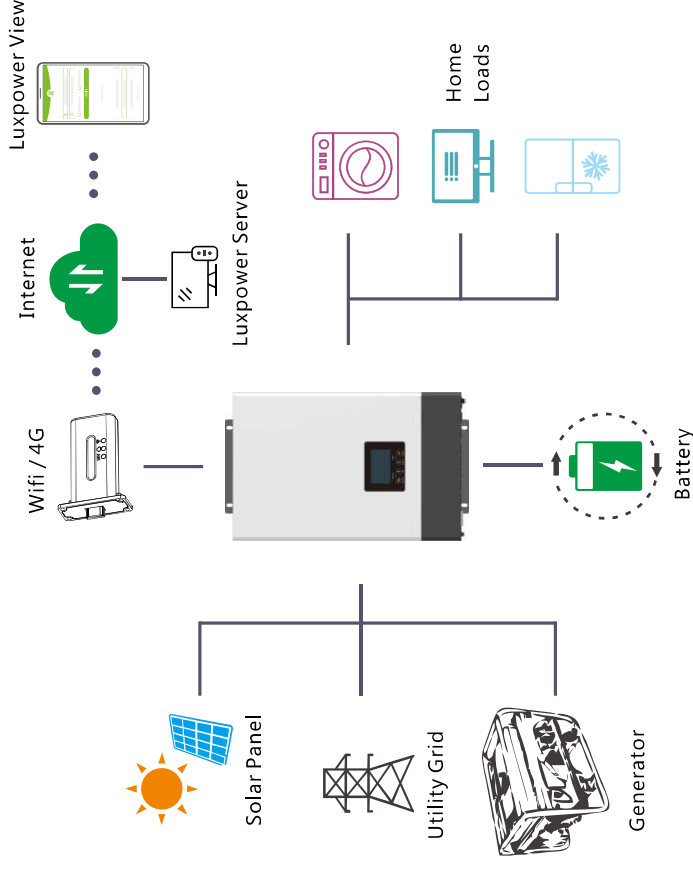

SONAR series is a multifunctional, high frequency pure sine wave off grid solar inverter, features:

- Applicable for pure off grid/backup power / self-consumption / on grid situation
- Integrated with 2 MPPT solar charge controllers, MPPT ranges 120V~385V
- Rated power 5KW, power factor 1
- Be able to run with or without battery in ongrid and offgrid mode
- With separated generator input interface, able to control generator remotely
- Solar and utility grid can power loads at the same time
- With integrated advanced parallel function, up to 10pcs max paralleling
- Support CAN/RS485 for Li-ion battery BMS communication
- WIFI/ GPRS remote monitoring , setting and firmware update, support website, free IOS/Android APP

1.2 Interface of the inverter

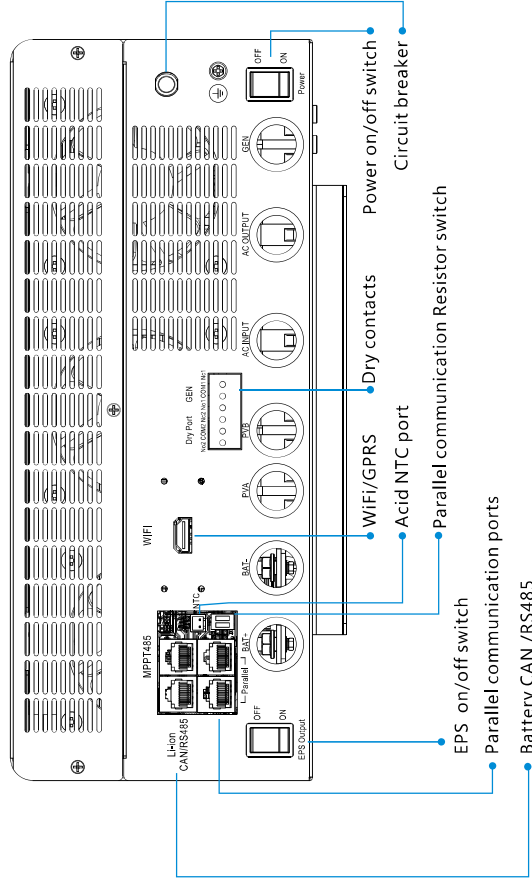
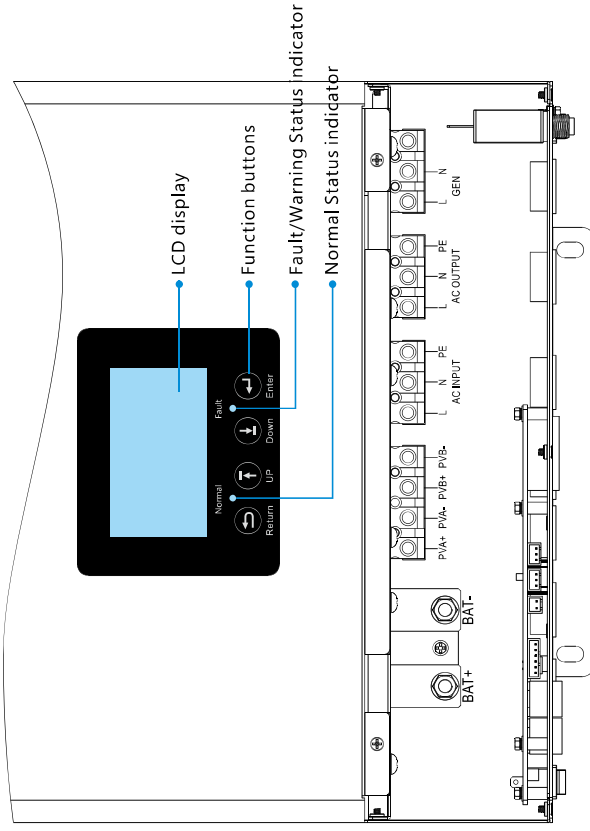

1.3 Packing List

Before installation, please inspect the unit. Be sure that nothing inside the package is damaged. You should have received the following items in the package:



Storing the Inverter

The inverter must be stored appropriately if not installed immediately, refer to below figure.

CAUTION !

- The inverter and its components must be stored in its original packaging.
- The storage temperature should be within $-25\sim 60^{\circ}\text{C}$ and humidity within $0\sim 85\%$.
- The packing should be upright and maximum stacked layers is 6 .
- Do not directly exposed the inverter and its packaging to sunshine, raindrops and keep away from corrosion.

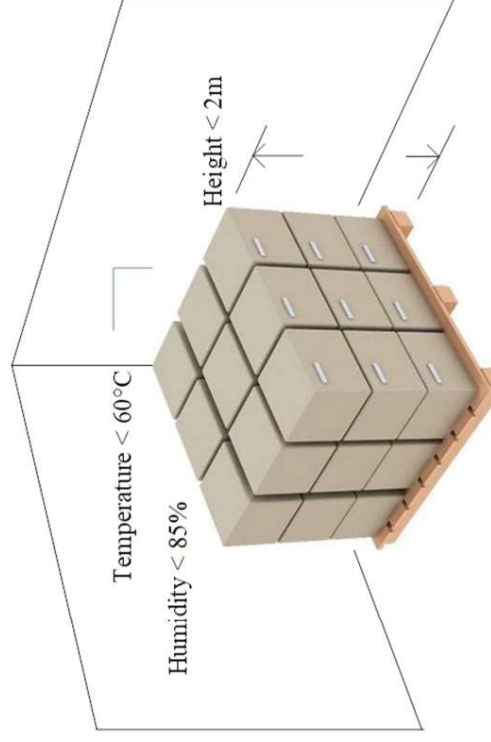

2. Installation

2.1 Preparation

The system connection is as below:

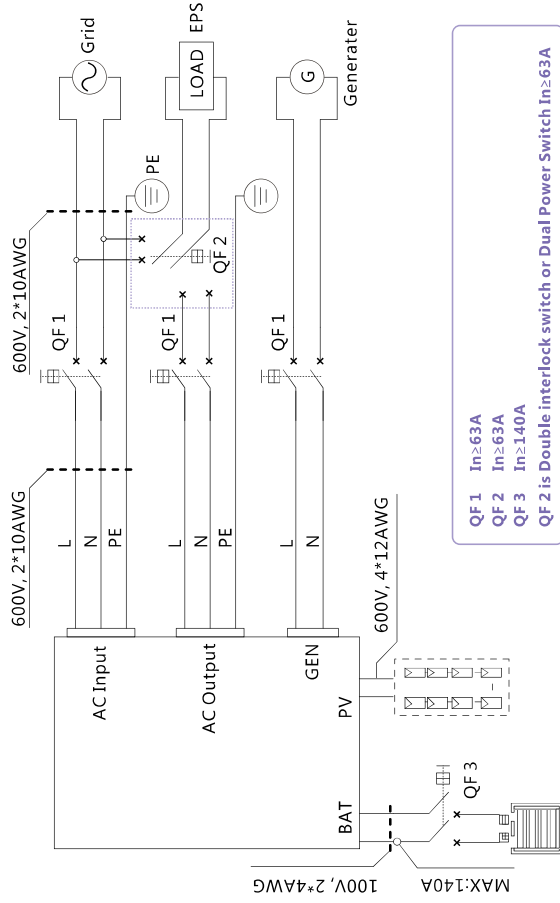

2. **AC connection:** Please install a separate AC breaker between inverter and AC input power source, inverter and AC output load. This will ensure the inverter can be securely disconnected during maintenance and fully protected from over current of AC input. The recommended spec of AC breaker is 32A. Recommended AC input/ AC output /GEN cable size for each inverter.

Model	Gauge	Cable (mm2)	Torque Value
SNA5000WPV	10AWG	6	1.2 Nm

3. **PV Connection:** Please install separately a DC circuit breaker between inverter and PV modules. The recommended of DC breaker is 600V/20A. It's very important for system safety and efficient operation to use appropriate cable for PV module connection. To reduce risk of injury, please use the proper recommended cable size as below:

Model	Gauge	Cable (mm2)	Torque Value
SNA5000WPV	1x12AWG	4	1.2 Nm

4. Before connecting all wiring, please take off bottom cover by removing 3 screws as shown below.

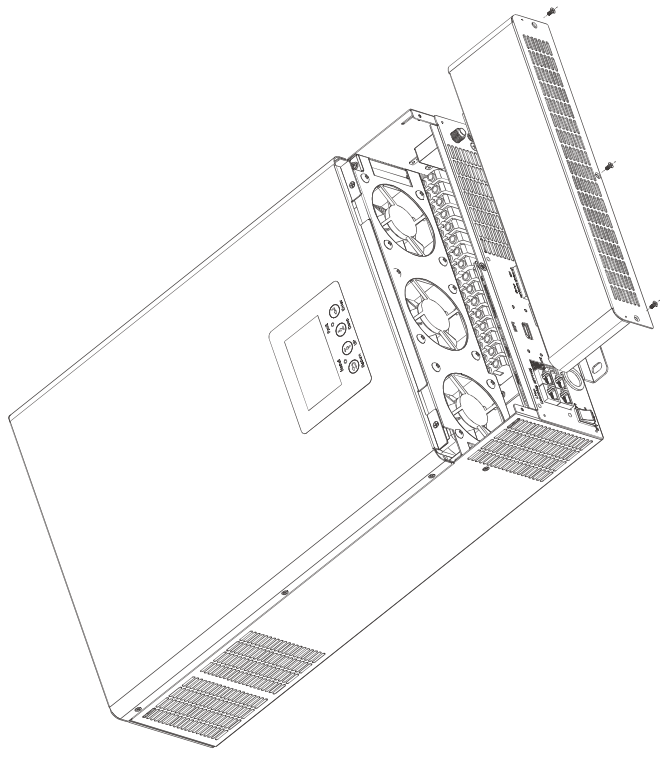

Please prepare the breakers and cables in advanced before installation.

1. **Battery connection:** For safety operation and regulation compliance, it's requested to install a separate DC over-current protector or disconnect device between battery and inverter. The recommended battery capacity is 150AH-200AH, the recommended spec of DC breaker is 150A/60V. Recommended battery cable and terminal size:

Model	Maximum Amperage	Battery capacity	Wire Size	Ring Terminal		Torque value
				Cable mm2	Dimensions D (mm) L (mm)	
SNA5000WPV	110A	200AH	1*2AWG	38	6.4 39.2	2~ 3 Nm
			2*6AWG	28	6.4 33.2	

2.2 Mounting the Unit

Notice: Consider the following points before selecting where to install:

- Mount on a solid surface
- Do not mount the inverter on flammable construction materials.
- For proper air circulation to dissipate heat, allow a clearance of approx. 20 cm to the side and approx. 50 cm above and below the unit.
- The ambient temperature should be between 0°C and 55°C to ensure optimal operation.
- The recommended installation position is to be adhered to the wall vertically.

Steps to mounting the unit

Step1. Use the wall-mounting bracket as the template to mark the position of the 4 holes, then drill 8 mm holes and make sure the depth of the holes is deeper than 50mm.

Step2. Install the expansion tubes into the holes and tight them, then use the expansion screws (packaged together with the expansion tubes) to install and fix the wall-mounting bracket on the wall.

Step3. Install the inverter on the wall-mounting bracket and lock the inverter using the security screws.

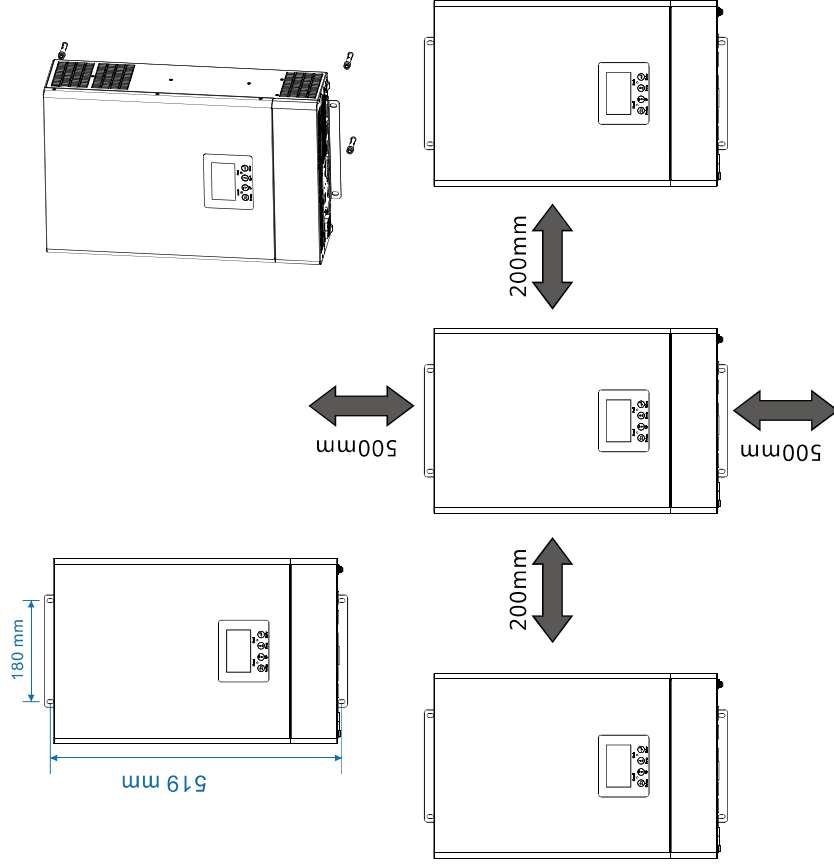

2.3 Battery Connection

2.3.1 Battery Power Cable Connection

Note: for lead acid battery, the recommended charge current is 0.2C(C to battery capacity)

1. Please follow below steps to implement battery connection:
2. Assemble battery ring terminal based on recommended battery cable and terminal size.
3. Connect all battery packs as units requires. It's suggested to connect at least 200Ah capacity battery for SNA5000 WPV.
4. Insert the ring terminal of battery cable flatly into battery connector of inverter and make sure the bolts are tightened with torque of 2 ~ 3Nm. Make sure polarity of the battery is correctly connected and ring terminals are tightly screwed to the battery terminals.

2.3.2 Lithium Battery Connection

If choosing lithium battery for SNA5000 WPV, please make sure the battery BMS is compatible with Luxpower inverter. Please check the compatible list in the Luxpower website.

Please follow below steps to implement lithium battery connection:

1. Connect power cable between inverter and battery
2. Connect the CAN or RS485 communication cable between inverter and battery. If you do not get the communication cable from inverter manufacturer or battery manufacturer, please make the cable according to the PIN definition

3. Lithium battery configuration, in order to communicate with battery BMS, you should set the battery type to "Li-ion" in Program "03" by LCD and choose the right battery brand (for details, please check the LCD setting chapter), users can also choose the battery type and brand by monitor system.



Pin	RS 485 port	CAN port
1	RS 485B	---
2	RS 485A	---
3	---	CANL
4	---	CANH
5/6	---	---
7/8	---	---

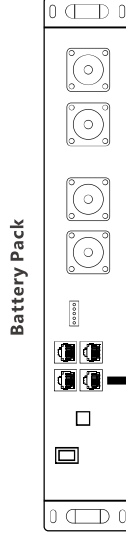
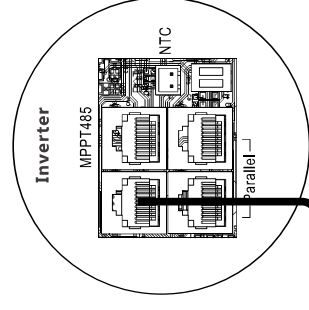

2.4 AC Input/Output Connection

CAUTION!!

- There are two terminal blocks with "IN" and "OUT" markings. Please do NOT mis-connect input and output connectors.
- Be sure to connect AC wires with correct polarity. If L and N wires are connected reversely, it may cause utility short-circuited when these inverters are worked in parallel operation.

Please follow below steps to implement AC input/output connection:

1. Before making AC input/output connection, be sure to open DC protector or disconnected first.
2. Remove insulation sleeve 10mm for six conductors. And shorten phase L and neutral conductor N 3 mm.
3. Insert AC input wires according to polarities indicated on terminal block and tighten the terminal screws. Be sure to connect PE protective conductor first.
4. Insert AC output wires according to polarities indicated on terminal block and tighten terminal screws. Be sure to connect PE protective conductor first.
5. Make sure the wires are securely connected.

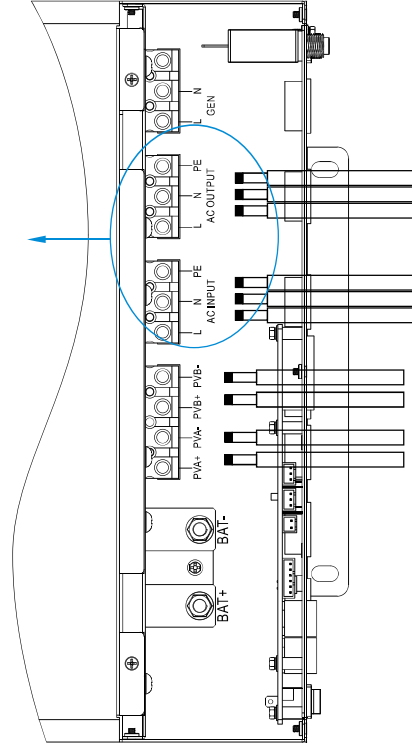
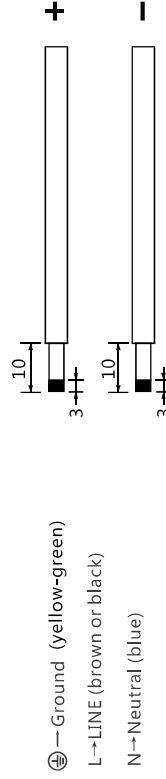

2.5 PV Connection

Please follow below steps to implement PV module connection:

1. Remove insulation sleeve 10 mm for positive and negative conductors.
2. Check correct polarity of connection cable from PV modules and PV input connectors.
3. Connect positive pole (+) of connection cable to positive pole (+) of PV input connector. Connect negative pole (-) of connection cable to negative pole (-) of PV input connector.
4. Make sure the wires are securely connected.
5. Finally, after connecting all wiring, please put bottom cover back by screwing two screws as shown below.

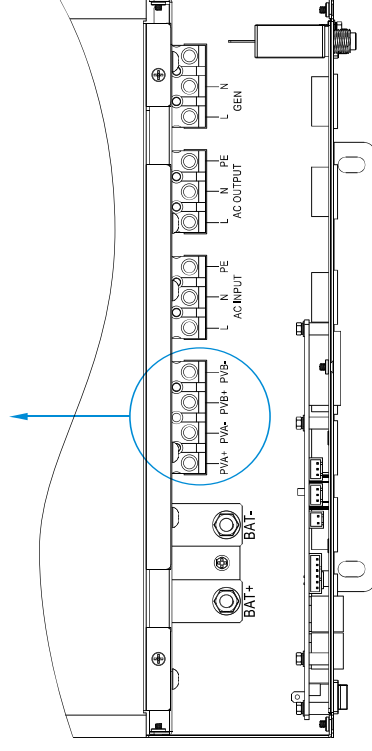

2.6 Generator Connection

L → LINE (brown or black) N → Neutral (blue)

1. Before making Generator connection, be sure to open DC protector or disconnected first.
2. Remove insulation sleeve 10mm for 2 conductors.
3. Insert L and N wires according to polarities indicated on terminal block and tighten the terminal screws

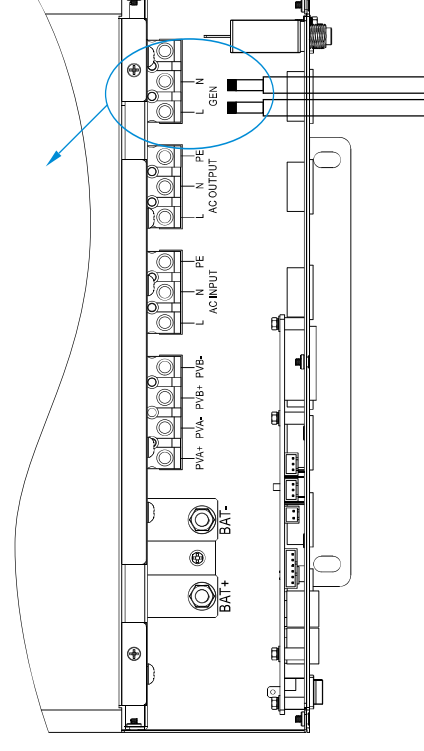

All lux units can work with generator.

- Users can connect the generator output to off grid inverters. GEN input terminal.
- The generator will be automatically started when battery voltage is lower than the cut-off value or there is charge request from BMS. When voltage is higher than AC charge setting value, it will stop the generator
- Battery will get charged when the generator is turned on, and the generator is bypassed to AC output to take all loads .

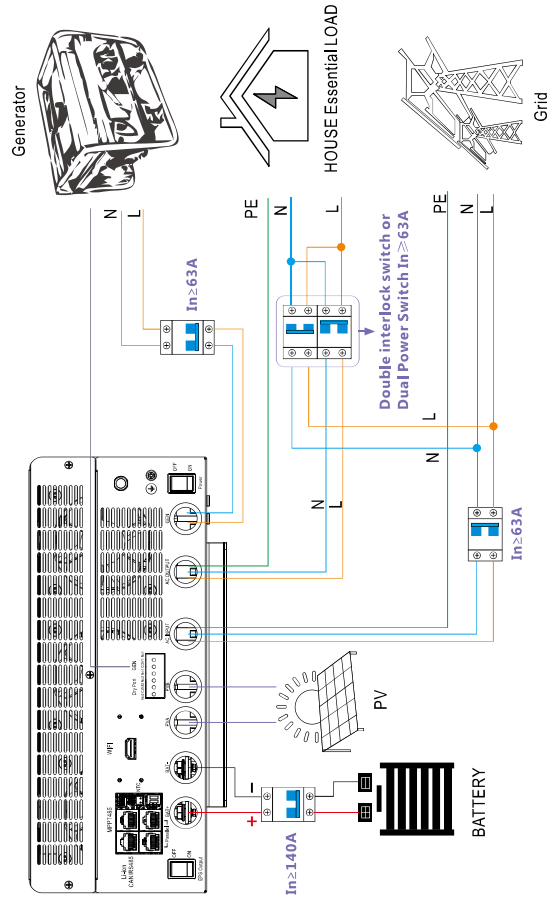

- The system will use AC first if there is both utility input and generator input.

2.7 Dry Contact Signal control

The Dry port(NO2,COM2,NC2) could be used to deliver signal to external device when battery voltage reaches warning level. The GEN port(NO1,COM1,NC1) could be used to wake-up the Generator and then the generator can charge the battery.

Unit Status	Condition	Dry port NO2 COM2 NC2	GEN NO1 COM1 NC1	Dry port NO2 COM2 NC2	GEN NO1 COM1 NC1
Power Off	Inverter is off and no output is powered.	Open	Close	Open	Close
Power On	Without Grid	Close	Open	Close	Open
	With Grid	Open	Close	Open	Close

Notice: NO---Normal open NC---Normal close

2.8 Parallel function

SNA series inverter support up to 10 units to composed single phase parallel system or three phase parallel system, for parallel system setup

Step1. Cable connection: the system connection is as below:

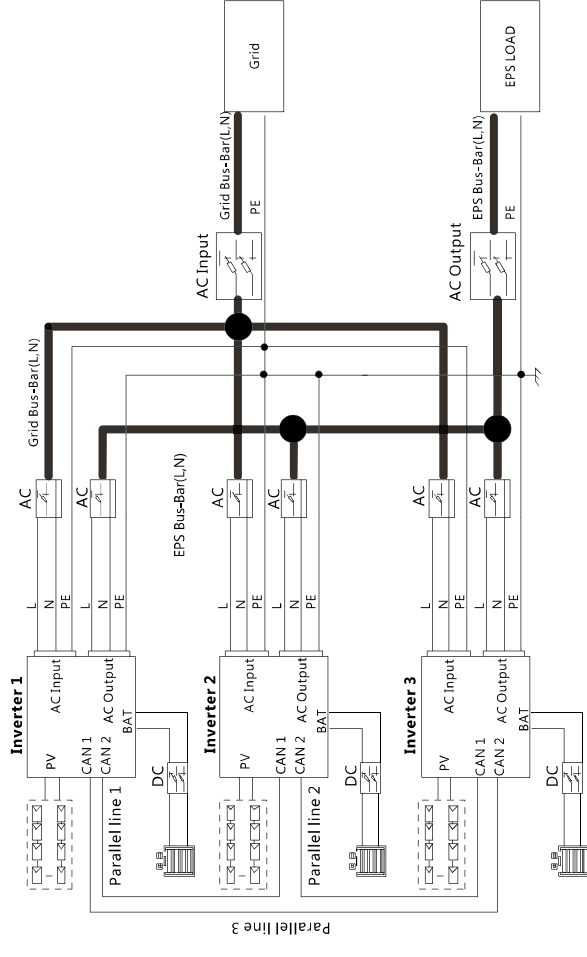

Step3. Setup the monitor for the system, add all dataloggs in one station. Users can login to the visit interface of monitor system, Configuration->station->Plant Management->add datalog to add the datalogs.

Step4. Enable share battery for the system if the system share one battery bank, otherwise disable the shared battery function

Step5. Set the system as a parallel group in the monitor system

Serial Number	Status	Solar Power	Charge Power	Discharge Pow.	Load	Solar Yielding	Battery Dischar	Fast Energy	Consumption E	Plant Name	Parallel	Action
1 0272011008	Normal	228 W	42 W	0 W	182 W	215.3 kWh	39.6 kWh	0 kWh	557.2 kWh	Dragonview A-1	Parallel	Parallel
2 0272011011		35 W	32 W	0 W	0 W	156.7 kWh	21.1 kWh	0 kWh	160.5 kWh	Dragonview A-2	Parallel	Parallel
3 0272011012		1 kW	129 W	0 W	1 kW	170.3 kWh	49.9 kWh	0 kWh	434.5 kWh	Dragonview A-3	Parallel	Parallel
4 0272011017		79 W	48 W	0 W	106 W	99 kWh	85.6 kWh	0 kWh	257.1 kWh	Dragonview A-4	Parallel	Parallel

For more detailed guidance for paralleling system, please visit <https://www.luxpowertek.com/download/> And download the guidance

2.9 Power and EPS ON/OFF

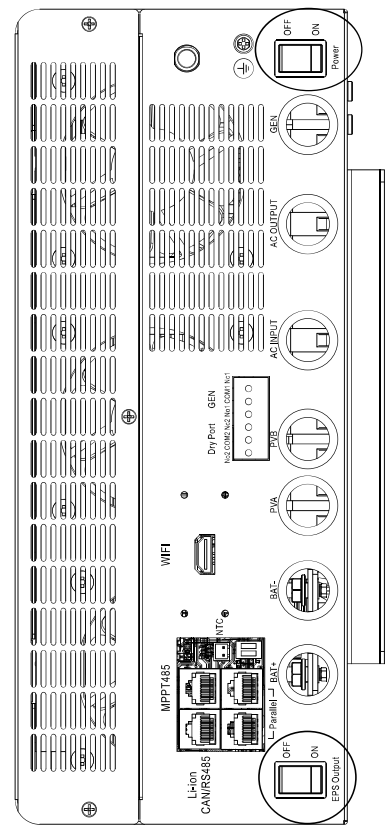

1. Power Switch: Control power supply for the unit
 2. EPS Output Switch: Use to control the AC output
- After connection, please turn on both switch. Users can turn off the EPS output switch to turn off power supply in some emergency case

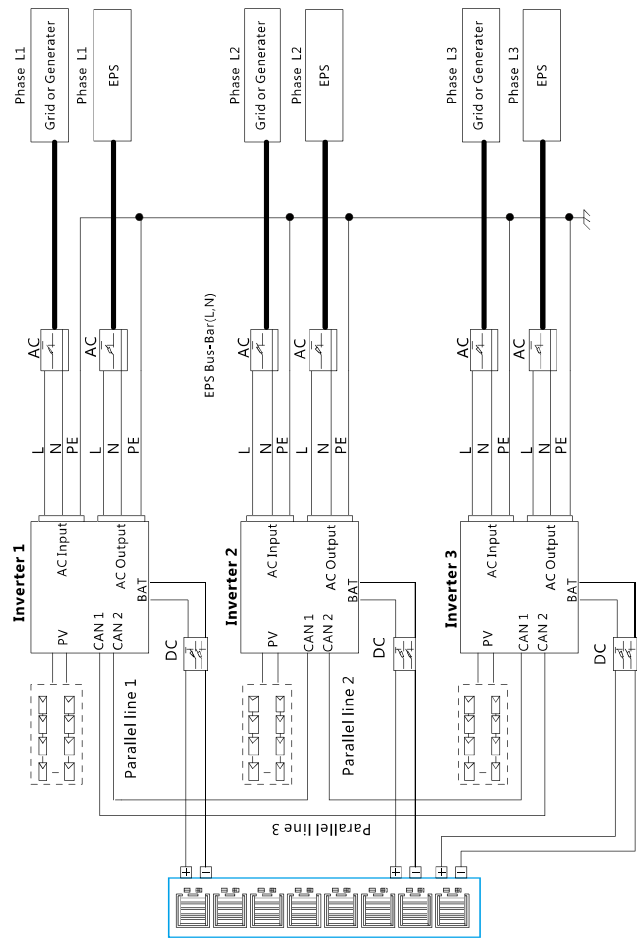

Step2. Please put the CAN communication PIN to on status for the first and the end inverter

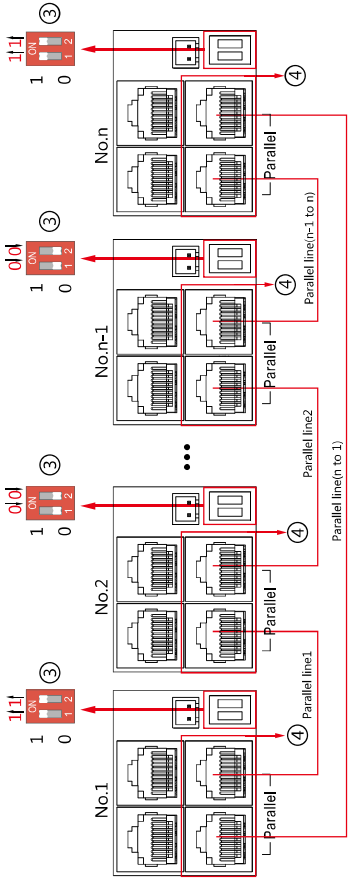

The max parallel quantity is 10, so 2 ≤ n ≤ 10

3. Working modes

3.1 Offgrid modes introduction:

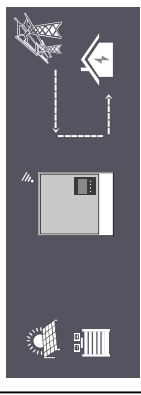
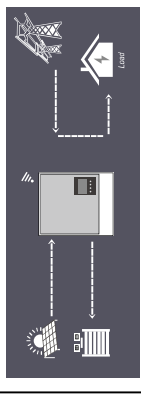
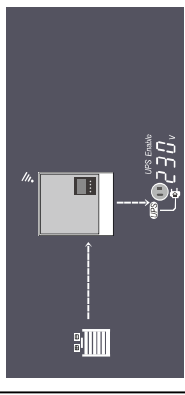
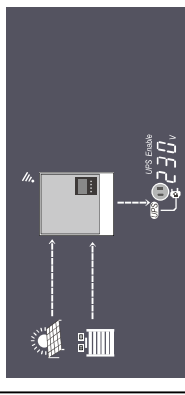
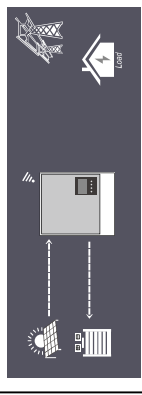
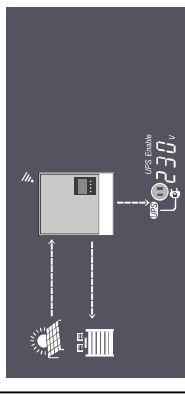
Bypass Mode		AC is used to take the load
PV Charge Bypass		PV charge the battery while the AC power the load
BAT Grid off		Battery is used to take the load
PV +BAT Grid off		PV + Battery power the load together
PV Charge		<ol style="list-style-type: none"> 1. When the EPS key off, the inverter charge the battery only 2. When the battery is power off, the PV can wake up the battery automatically
PV Charge +Grid off		PV charge the battery and power the load

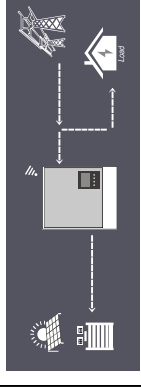
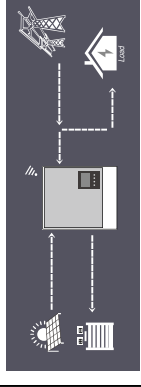
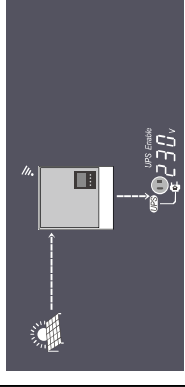
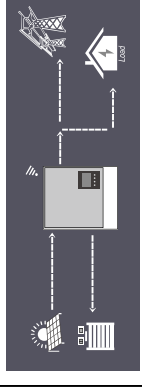
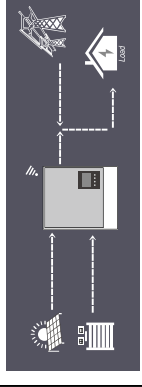
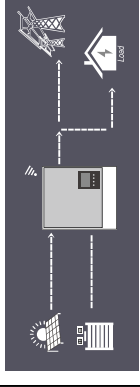
AC Charge		<ol style="list-style-type: none"> 1. AC charge the battery from AC Input or GEN Input 2. When the battery is power off, the AC can wake up the battery automatically
PV +AC charge		<p>PV +AC charge the battery AC is from AC Input or GEN Input</p>
PV Grid off		<p>NOTE: The output power depends on the PV energy input, if the PV energy is unstable, witch will influence the output power</p> <p>When setting without battery, the PV can power the load .</p>
PV charge Gridon		<p>PV charge battery and power the load *The rest power from PV can feed in Grid</p>
PV + BAT Gridon		<p>PV + Battery power the load , and the AC can power the load if PV +Battery power not enough</p>
PV Gridon		<p>PV power the load, the rest power feed in Grid</p>

3.2 Working Modes related setting description

Situation	Setting 1	Setting 2	Setting 3	Working modes and Description	
AC abnormal	NA	NA	NA	Off grid mode if P_Solar >= P_Load, solar is used to take load and charge battery if P_Solar < P_Load, solar and battery take the load together, system will discharge until battery lower than the Cut Off Voltage/SOC	
AC normal	PV&AC Take Load Jointly Enable	In the AC first time	NA	Hybrid Mode 1(charge first) Solar power will be used to charge battery first, 1.The solar power will be used to charge the battery first. AC will take load. 2.If solar power is higher than power need to charge the battery, the extra power will be used to take load together with grid 3.If there is still more energy after charge battery and take the load, it will feed energy into grid if export to grid function is enabled	
		Enable AC charge and in the AC charge time	AC charge according to Time	Hybrid Mode 1(charge first)+AC charge battery if solar power is not enough to charge battery	
	PV&AC Take Load Jointly Disable	1. Not in the AC first time and 2. Disable AC charge or not in the AC charge time	NA	NA	Hybrid Mode 1(charge first)+AC charge battery if solar power is not enough to charge battery and the battery voltage/SOC is lower than AC start charge voltage/SOC, the AC will stop charging when the battery Voltage/SOC is higher than AC end charge battery voltage/SOC Hybrid Mode 2(load first) Solar power will be used to take load first, 1.If solar power is lower than load, battery will discharge together to take load until battery lower than EOD voltage/SOC 2.If solar power is higher than load, the extra power will be used to charge battery, if there is still more energy, it will feed into grid if enable export
		Enable AC charge and in the AC charge time	AC charge according to Time	NA	Bypass Mode AC will take the load and Solar is used to charge battery Bypass Mode+AC charge battery Solar is used to charge battery AC will take load and also charge battery during AC charge time if solar power is not enough
		1. Not in the AC first time and 2. Disable AC charge or not in the AC charge time	NA	Bypass Mode+AC charge battery Solar is used to charge battery AC will take load and also charge battery when battery SOC/Voltage is lower than start SOC/Voltage, and the AC will stop charging when the battery Voltage/SOC is higher than AC end charge battery voltage/SOC Off grid mode if P_Solar >= P_Load, solar is used to take load and charge battery if P_Solar < P_Load, solar and battery take the load together, system will discharge until battery lower than EOD Voltage/SOC	

1. SONAR can work as traditional off grid inverter or as a hybrid inverter. When disable PV&AC Take load Jointly, it will work as a traditional off grid inverter, otherwise it will work as a hybrid

Hybrid Setting

PV&AC Take Load Jointly Enable Disable Set

Discharge Current Limit

Export to Grid Enable Disable Set

Export Power Percent(%)

2. Working as a traditional off grid inverter. In this situation, inverter either use (solar+battery) to take load or use AC take load. Related settings

Application Setting

EPS Voltage Set(V) EPS Frequency Set(Hz)

AC Input Range

AC First

AC first Start Time 1 : : AC first Start Time 2 : :

AC first End Time 1 : : AC first End Time 2 : :

AC first Start Time 3 : :

AC first End Time 3 : :

AC First: During the setting time, system will use AC to take load first, use solar power to charge the battery. If the battery is full, solar power may be wasted. When out of the setting time, system will use battery and solar to take load until battery voltage/SOC is lower than cut off voltage/SOC

Discharge Setting

Discharge Control

Battery Warning Voltage

Battery Warning Recovery Voltage

Battery Warning SOC

Battery Warning Recovery SOC

Discharge Cut-off Voltage

Discharge Cut-off SOC

On Grid EOD Voltage(V)

On Grid EOD SOC(%)

3. Working as a hybrid inverter Related settings

Application Setting

EPS Voltage Set(V) EPS Frequency Set(Hz)

AC Input Range

AC First

AC first Start Time 1 : : AC first Start Time 2 : :

AC first End Time 1 : : AC first End Time 2 : :

AC first Start Time 3 : :

AC first End Time 3 : :

3.1 AC First: During this setting time, system will use AC to take load, use solar power to charge the battery first. If there is extra solar power, extra solar power will take the load. When out of the setting time, system will use solar and battery to take load first until the battery voltage/SOC is lower than On Grid EOD settings, then it will use AC to take the load.

Discharge Setting

Discharge Control

Battery Warning Voltage

Battery Warning Recovery Voltage

Battery Warning SOC

Battery Warning Recovery SOC

Discharge Cut-off Voltage

Discharge Cut-off SOC

On Grid EOD Voltage(V)

On Grid EOD SOC(%)

3.2 Export to Grid/Export Power percent: Users can also enable export function, it is allowed and set export power percent

AC Charge

AC Charge

AC Charge Battery Current(A)

AC Charge Start Time 1 : : AC Charge Start Time 2 : :

AC Charge End Time 1 : : AC Charge End Time 2 : :

AC Charge Start Battery Voltage(V) AC Charge End Battery Voltage(V)

AC Charge Start Battery SOC(%) AC Charge End Battery SOC(%)

3.3 AC Charge function Disable: The system will not use AC to charge the battery(except Li ion BMS set force charge flag)

- According to Time: During the setting time, system will use AC to charge the battery until battery full and battery will not discharge during the setting time.
- According to Battery Voltage: During the setting time, system will use AC to charge the battery if battery voltage is lower than AC Charge Start Battery Voltage and will stop when Voltage is higher than AC Charge End Battery Voltage. And battery will not discharge during the setting time.
- According to Battery SOC: During the setting time, system will use AC to charge the battery if battery SOC is lower than AC Charge Start Battery SOC and will stop when Voltage is higher than AC Charge End Battery SOC. And battery will not discharge during the setting time.

4. LCD display and settings

4.1 LED Display

LED Indicator	Messages
1 Green	Working normal fast: Warning slow: Firmware update
2 Red	Fault condition occurs in the inverter

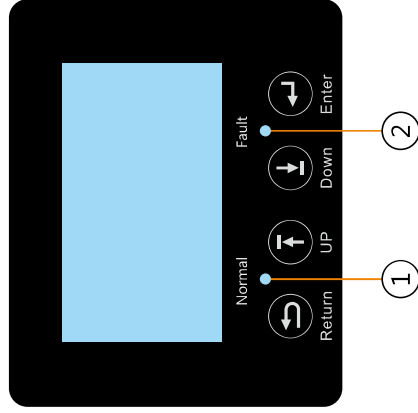

4.2 LCD Display

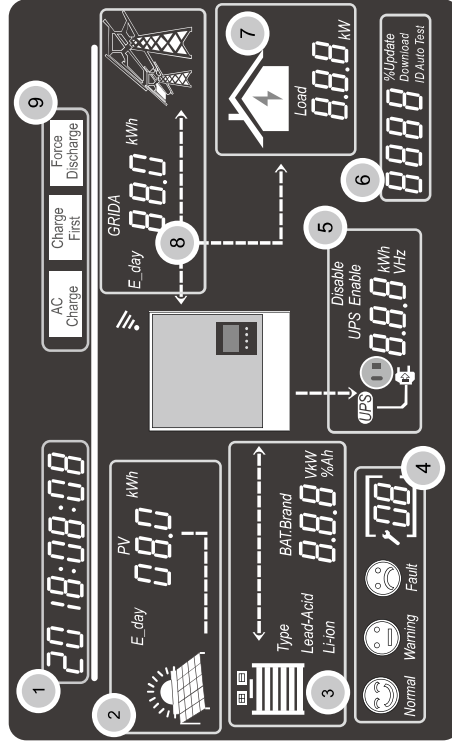





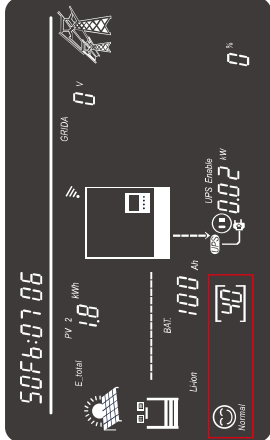
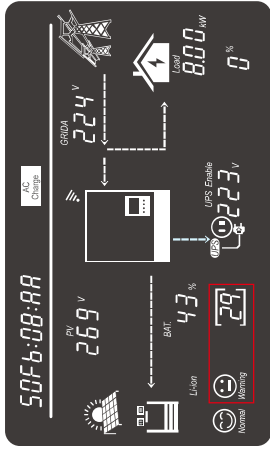
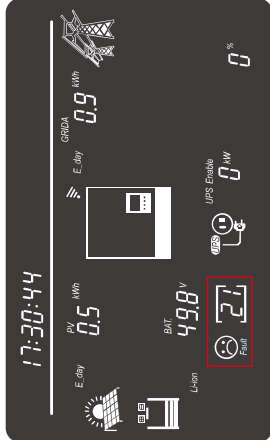
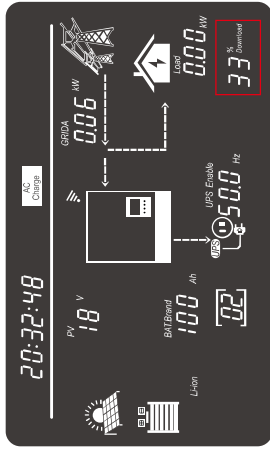
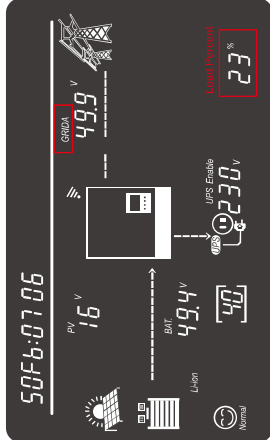
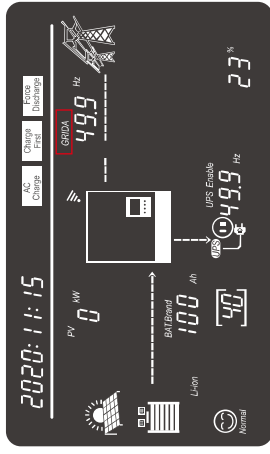

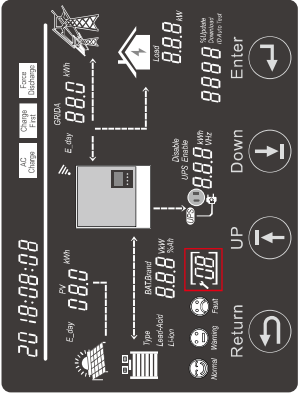
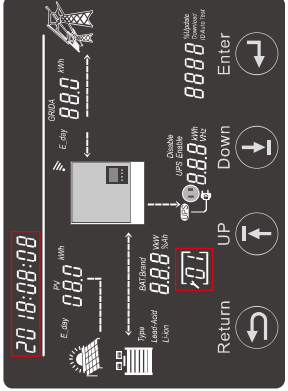

No.	Description	Remarks
1	Generally Information Display Area	This area will display the currently time/date by default(year/month/day/ hour/minute" switching automatically). When press Up or Down buttons, this area will display the firmware version information, serial number etc. Display the setting selection information when entering settings
2	On-grid solar inverter output power and energy data	This area shows the data of PV voltage, power and the setting of PV input connection information
3	Battery information and data	This area shows the battery type, battery brand(lithium battery), the lead-Acid battery setting of CV voltage, Floating charging voltage, Cut off voltage, Discharge end voltage . And display the voltage, SOC and power in turns of period of 1 seconds
4	System working status / setting code	There are three type of working status- normal, warning and fault, in right side of this area, there are code display, it will display different type of code-the system working mode code, warning code, fault code and setting code
5	UPS/EPS output information and data	When UPS function is enabled, this area will display UPS voltage, frequency, power etc. in turns of periods of 1s
6	Programming & the percentage of AC output power	When firmware updating in process, it will display relevant information When in grid off, this area will display the Percentage of the maximum AC output power
7	Loads consumption	Display the power consumption by the loads in on grid model
8	Grid information and Generator information	Display the grid(GRIDA) information of voltage, frequency, input or output power, the Generator (GRIDB) information of voltage, frequency, input power ,switch period of 1s
9	Working mode settings area	When make settings on the SNA5000 inverter through the LCD, this area will display the AC Charge, Force Discharge, Charge First option for setting on those working modes. It will not display those information unless in the setting process.

4.3 Inverter Status Display

<p>Normal status, running status 40</p> 	<p>Warning Status, warning 29</p> 
<p>Fault status, fault 21</p> 	<p>Flash status:download percent is 33%</p> 
<p>When display 'GRIDA', it means the Grid information is about AC utility, The percent display on the right down corner means the load percentage</p> 	<p>When display 'GRIDB', it means the AC information is about Genset input</p> 

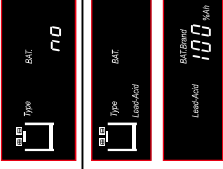
4.4 LCD Settings

<p>Return UP Down Enter</p> <p>There are four buttons on the LCD. Step for settings by the display:</p> <p>Step1: After touch Enter-button for about 2 seconds, the unit will enter setting mode. The setting icon and index will flashing.</p> <p>Step2:Touch UP or Down button to select setting index from 1 to 19.</p> <p>Step3: Then touch Enter button to set this item</p> <p>Step4: Touch UP or Down button to change the settings</p> <p>Step5: Touch Enter to confirm the setting or Return the setting list is as below</p> 	<p>Setting Option</p> <p>Setting Year/Month/day</p>  <p>Setting hour/minute/second</p> 	<p>Default: S</p> <p>S: two independent Strings input</p>  <p>P:Same string input for 2 MPPTs</p>  <p>dc: DC source input</p> 
<p>Index</p> <p>Description</p> <p>1 Date& time</p> <p>2 PV input mode</p>	<p>Index</p> <p>Description</p> <p>1 Date& time</p> <p>2 PV input mode</p>	<p>Index</p> <p>Description</p> <p>1 Date& time</p> <p>2 PV input mode</p>

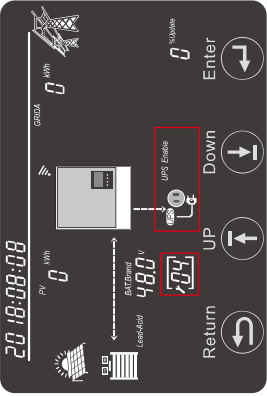
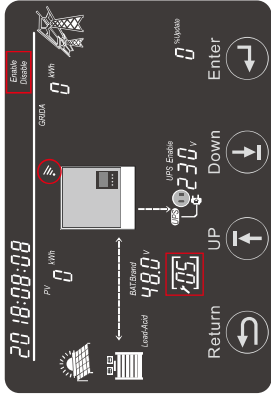
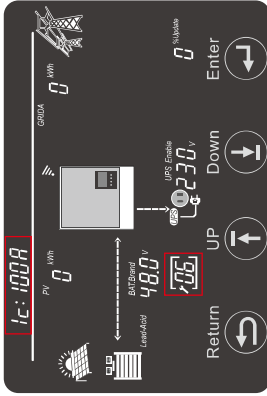
	<p>Run with No Battery:</p> <p>Step1: Choose battery type first, when no flashing, select Enter to choose Run with No battery</p>	
3	<p>For Lead Acid:</p> <p>Step1: Choose battery type first, when Lead-Acid flashing, select Enter to choose Lead-acid battery</p> <p>Step2: Then choose battery capacity</p>	 
	<p>For Lithium battery</p> <p>Step1: Choose battery type first, when Li-ion flashing, select Enter to choose Li-ion battery</p> <p>Step2: Choose battery brand</p> <p>0 -> Standard Battery 2 -> Pylon Battery</p> <p>6 -> Luxpower protocol Battery 8 -> Dyness Battery</p>	 
4	<p>Off grid Output voltage and frequency</p>	 <p>AC Output voltage 208Vac/220Vac/ 230Vac(Default)/240Vac</p> <p>AC Output frequency 50Hz (Default)/60Hz</p>
5	<p>Buzzer enable</p>	 <p>Buzzer enable (Default)</p> <p>Buzzer Disable</p>
6	<p>Ic: Maximum charge current (utility charge current + solar charge current)</p>	 <p>Total charge current setting Setting range :10A~140A Default: 110A</p>

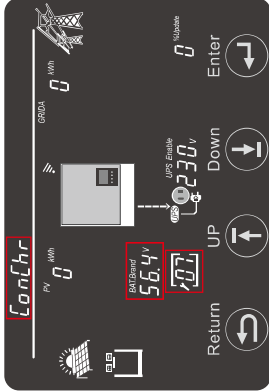
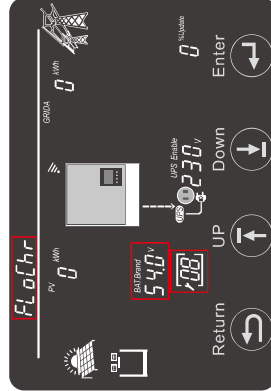
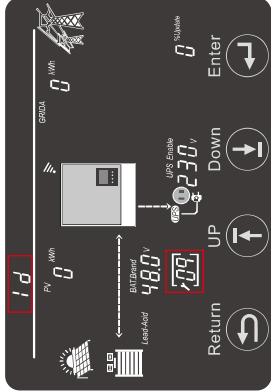
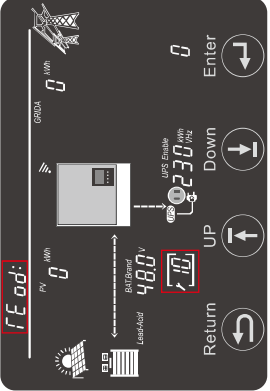
7	<p>ConChr: CV voltage setting (Only in Lead-acid battery type)</p>	 <p>Setting range: 50.0~59.0V/dc Default: 56.4V</p>
8	<p>FloChr: Floating charging voltage setting (Only in Lead-acid battery type)</p>	 <p>Setting range: 50.0~56.0V/dc Default: 54.0V</p>
9	<p>Id: Maximum discharge current</p>	 <p>Total discharge current setting Setting range :10A~140A Default: 110A</p>
10	<p>TEOd: Discharge control type: VOLT/SOC</p>	 <p>Setting Range: VOLT/SOC</p>

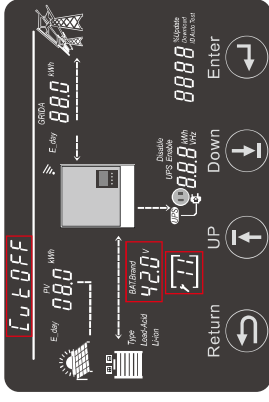
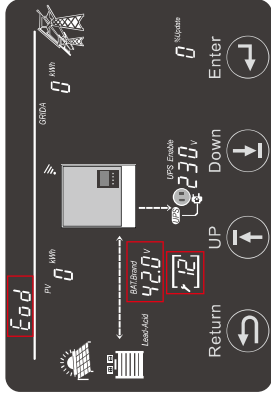
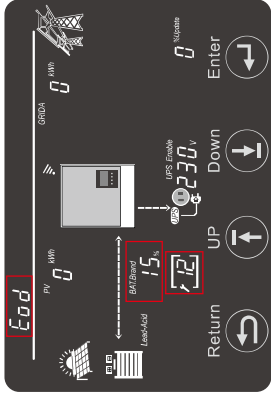
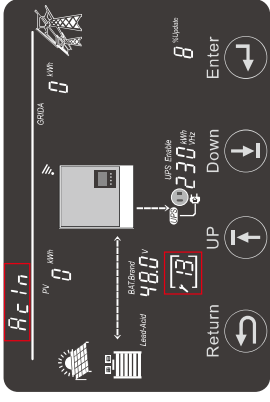
11	<p>CutOff: Cut off Voltage or SOC, depend on TEOD</p>	 <p>Setting range: VOLT: 40.0-OnGrid EOD Volt Default: 42V</p> <p>SOC: 0-OnGrid EOD SOC Default: 15%</p>
12	<p>Eod: Discharge end voltage or soc with grid, depend on TEOD</p>	 <p>Setting range: VOLT: Cut off Volt-56V Default: 42V</p> <p>SOC: Cut off SOC -90 Default: 15%</p>
12	<p>Eod: Discharge end voltage or soc with grid, depend on TEOD</p>	 <p>Setting range: VOLT: Cut off Volt-56V Default: 42V</p> <p>SOC: Cut off SOC -90 Default: 15%</p>
13	<p>Acin: AC voltage range setting</p>	 <p>Unity AC Input voltage range : 90Vac~280Vac</p> <p>AC Output voltage range : 170Vac~280Vac</p>

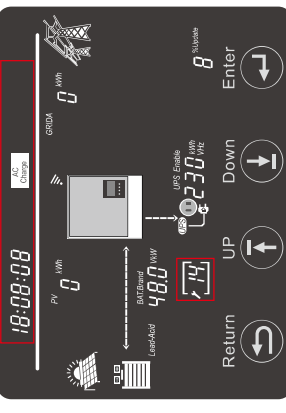
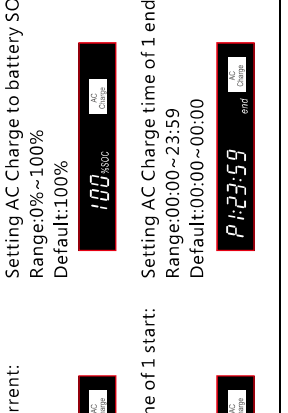
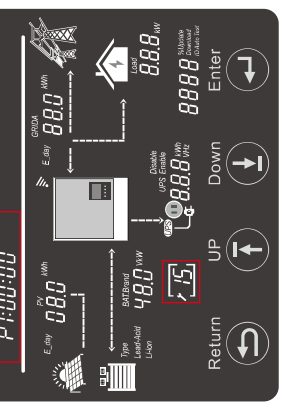
14	<p>AC charge setting (The setting process must enable the AC charging function, confirm the full battery SOC value, and set the confirmation time period 1, 2, 3 to truly complete the AC charging function setting)</p>	 <p>AC Charge function: Disable(Default) Enable (Touch "Enter" button to set ac charge parameter)</p> <p>Setting AC Charge current: 30A(Default) 40A / 50A / 60A</p> <p>Setting AC Charge to battery SOC: Range:0%~100% Default:100%</p> <p>Setting AC Charge time of 1 start: Range:00:00~23:59 Default:00:00~00:00</p> <p>Similar to set time2 and time3</p>
15	<p>Utility source (AC Input) to take Load time setting</p>	 <p>Setting time of 1 start: Range:00:00~23:59 Default:00:00~00:00</p> <p>Setting time of 1 end: Range:00:00~23:59 Default:00:00~00:00</p> <p>Setting time of 2 start: Range:00:00~23:59 Default:00:00~00:00</p> <p>Setting time of 2 end: Range:00:00~23:59 Default:00:00~00:00</p>
16	<p>Hybrid enable/ disable</p>	 <p>Setting Range: Hybrid Disable (default) Hybrid Enable Hybrid Enable</p>

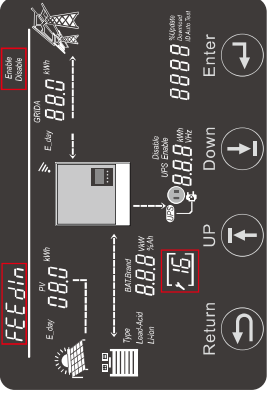
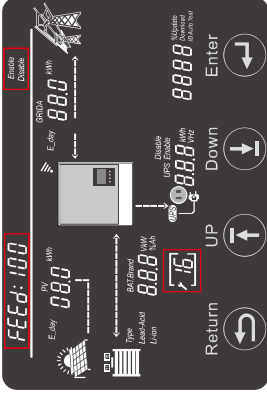
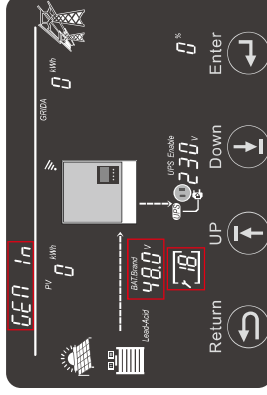
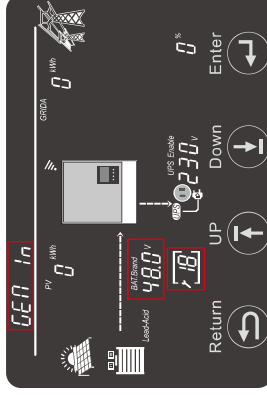
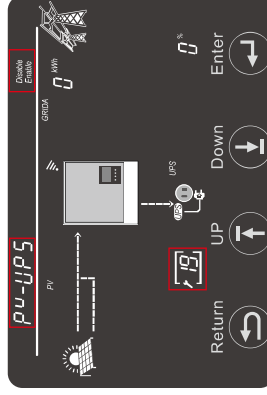
16	<p>Feed-in Enable/disable Only valid when Hybrid is enabled</p>		<p>Setting Range: Feed-In Disable (default)</p> <p>Disable</p> <p>Feed-In Enable</p> <p>Enable</p>
17	<p>Maximum Feed-In percent Only valid when Feed-In is enabled Power percent can be set larger than 100% in case of there is other generating device in the system</p>		<p>Setting Range:0-100% 0% (default)</p> <p>FEED: 100</p>
18	<p>Battery Wakeup Enable/disable (Not for No Battery type)</p>		<p>Enable wakeup battery</p> <p>YES</p>
19	<p>Max Generator Input Power</p>		<p>Setting Range:0-7369W 7369W (default)</p> <p>GEN: 7369</p>
19	<p>PV Off Grid enable/disable</p>		<p>Setting Range: PV Off Grid Enable (default)</p> <p>Enable</p> <p>PV Off Grid Disable</p> <p>Disable</p>

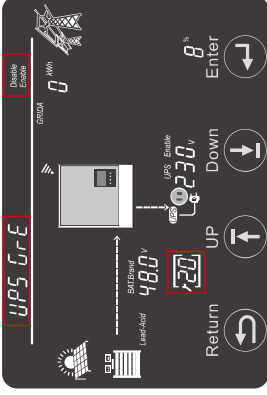
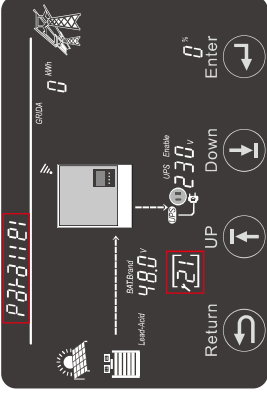
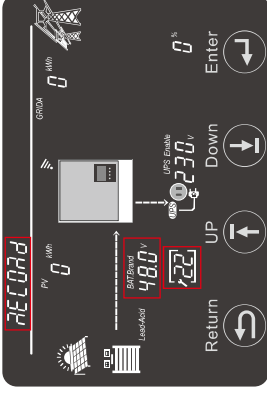
20	<p>Green Function enable/disable</p>		<p>Setting Range: Green Function Disable (default)</p> <p>Disable</p> <p>Green Function Enable</p> <p>Enable</p>
21	<p>Parallel setting</p>		<p>Parallel type setting Setting Range: NoPL (not Parallel)/1PH (Single phase)/3PH (Three phase) NoPL (default)</p> <p>PAR: 1PH</p> <p>Parallel phase setting Setting Range: P1 (Rphase)/P2(Sphase)/P3(Tphase) P1 (default)</p> <p>PHAS: P1</p> <p>Bat Share enable/disable Setting Range: Disable (default) Enable</p> <p>BATSHARE</p>
22	<p>Error/Alarm Record</p>		<p>Error Record -> Record Index ->> Record Msg: (Year: Month:Day; Hour: Min:Sec; Error code)</p> <p>Err REC</p> <p>Alarm Record -> Record Index ->> Record Msg: (Year:Month:Day; Hour:Min:Sec; Alarm code)</p> <p>ALM REC</p>

5. Monitor System for Off grid

- Users can use wifi dongle / WLAN dongle / 4G dongle (Available from 2021 March for some countries) to monitor the energy storage system. The monitor website is: server.luxpowertek.com
- The APP is also available in the google play and apple APP store(Scan two code bar to download the APP).
- Please download the introduction of guidance by website: <https://www.luxpowertek.com/download/>
Document Reference:

1. Wifi Quick Guidance

Quick guidance for setting password for wifi module, the paper is also available in the wifi box

- ### 2. Monitor system setup for Distributors and Monitor system setup for endusers
- Monitor system registration, wifi password setting, and wifi local monitor and setting

3. Lux_Monitor_UI_Introduction

Introduction of monitor interface

4. WebsiteSettingGuidance

Introduction of website settings for offgrid inverter

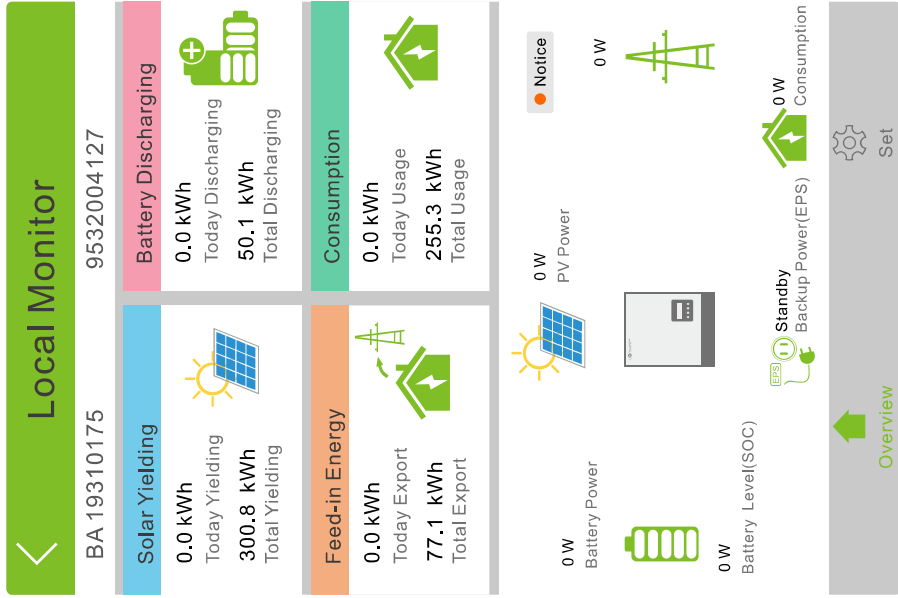

6. Specifications

Table 1 Line Mode Specifications	
INVERTER MODEL	SNA5000WPV/SNA4000WPV/SNA3000WPV
Input Voltage Waveform	Sinusoidal (utility or generator)
Nominal Input Voltage	230Vac
Low Loss Voltage	170Vac±7V (UPS); 90Vac±7V (Appliances)
Low Loss Return Voltage	180Vac±7V (UPS); 100Vac±7V (Appliances)
High Loss Voltage	280Vac±7V
High Loss Return Voltage	270Vac±7V
Max AC Input Voltage	280Vac
Nominal Input Frequency	50Hz / 60Hz (Auto detection)
Output Short Circuit Protection	Software protect when GridOff discharge Circuit Breaker protect when GridOn Bypass
Transfer Time	<20ms @ Single < 30ms @ Parallel
Output power derating: When AC input voltage drops to 170V, the output power will be derated.	Output Power Rated Power 20% Power
Charge power derating: When AC input voltage drops to 170V depending on models, the charge power will be derated.	<p>Rated Power 50% Power</p>
Output power derating: When AC input voltage drops to 200V, the output power will be derated.	Max inv current: 25A; Max inv Power: 5KW;
Table 2 Inverter Mode Specifications	
Rated Output Power	5KVA/5KW 4KVA/4KW 3KVA/3KW
Output Voltage Waveform	Pure Sine Wave
Output Voltage Regulation	208Vac/220Vac/230Vac/240Vac±5%
Output Frequency	50Hz / 60Hz
Peak Efficiency	93%
Overload Protection	5s@≥150% load; 10s@110%~150% load
Surge Capacity	2* rated power within 5 seconds

Battery Voltage Range	46.4V-60V(Li)	38.4V-60V(Lead_Acid)
High DC Cut-off Voltage	59VDC(Li)	60VDC(Lead_Acid)
High DC Recovery Voltage	57.4VDC(Li)	58VDC(Lead_Acid)
Low DC Warning Voltage	load < 20%	44.0Vdc(Settable)
	20% ≤ load < 50%	Warning Voltage @load < 20% -1.2V
	load ≥ 50%	Warning Voltage @load < 20% -3.6V
Low DC Warning Return Voltage	Low DC Warning Voltage@Different load +2V	
Low DC Cut-off Voltage	load < 20%	42.0Vdc(Settable)
	20% ≤ load < 50%	Cut-off Voltage @load < 20% -1.2V
	load ≥ 50%	Cut-off Voltage @load < 20% -3.6V
Low DC Cut-off Return Voltage	Cut-off Voltage@load < 20% ≥ 45V	Low DC Cut-off Voltage @load < 20% +3V
	Cut-off Voltage@load < 20% < 45V	48V
Low DC Warning SOC	20% SOC (Settable)	
Low DC Warning Return SOC	Low DC Warning SOC + 10%	
Low DC Cut-off SOC	15% SOC (Grid on) (settable)	
	15% SOC (Grid off) (settable)	
Low DC Cut-off Return SOC	Low DC Cut-off SOC + 10%	
Charge Cut-off Voltage	58.4Vdc	
No Load Power Consumption	<60W	
Table 3 Charge Mode Specifications		
Utility Charging Mode		
Lead_Acid Battery Charging Algorithm	3-Step	
Max. AC Charging Current	60Amp(@VI/P = 230Vac)	
Bulk Charging Voltage	Flooded Battery	58.4Vdc
	AGM / Gel Battery	56.4Vdc
Floating Charging Voltage	54Vdc	

Charging Curve

MPPT Solar Charging Mode	Bulk (Constant Current)	Absorption (Constant Voltage)	Maintenance (Floating)
Max. PV Array Power	6400W		
Start-up Voltage	100Vdc±10Vdc		
PV Array MPPT Voltage Range	120Vdc~385Vdc		
Max. PV Array Open Circuit Voltage	480Vdc		
Max. PV Charging Current	110A		
Max. Charging Current (AC Charger Plus Solar Charger)	110A		
Table 4 General Specifications			
INVERTER MODEL	SNA5000WPV/SNA4000WPV/SNA3000WPV		
Safety Certification	CE		
Operating Temperature Range	0°C to 50°C		
Storage temperature	-15°C~ 60°C		
Humidity	5% to 95% Relative Humidity (Non-condensing)		
Altitude	<2000m		
Dimension(D*W*H)	505*330*135mm		
Net Weight	14.5Kg		

7. Trouble Shooting & Error List

The failures mainly divided into 5 categories, for each category, the behavior is different:

Code	Description	Trouble shooting
E000	Internal communication fault1	Restart inverter, if the error still exist, contact us (DSP&M3)
E002	Bat On Mos Fail	Restart inverter, if the error still exist, contact us (DSP&M3)
E003	CT Fail	Restart inverter, if the error still exist, contact us (DSP&M3)
E008	CAN communication error in Parallel System	Check CAN cable connection is connected to the right COM port
E009	No master in parallel system	Check parallel setting for master/Slave part, there should be one master in the system
E010	Multi master in parallel system	Check parallel setting for master/Slave part, there should be one master in the system
E011	AC inconsistent in parallel system	Check if AC Connection is same for all inverters in parallel system
E012	Off grid output short circuit	Check if the load is short circuit, try to turn off the load and restart inverter
E013	UPS reserve current	Restart inverter, if the error still exist, contact us
E015	Phase Error in three phase parallel system	Check if the AC connection is right for three phase system, there should one at least one inverter in each phase
E016	Relay fault	Restart inverter, if the error still exist, contact us
E017	Internal communication fault2	Restart inverter, if the error still exist, contact us (DSP&M8)
E018	Internal communication fault3	Restart inverter, if the error still exist, contact us (DSP&M3)
E019	Bus voltage high	Check if PV input voltage is higher than 480V
E020	EPS connection fault	Check if EPS and AC connection is in wrong terminal
E021	PV voltage high	Check PV input connection and if PV input voltage is higher than 480V
E022	Over current internal	Restart inverter, if the error still exist, contact us
E024	PV short	Check PV connection
E025	Temperature over range	The internal temperature of inverter is too high, turn off the inverter for 10minutes, restart the inverter, if the error still exist, contact us
E026	Internal Fault	Restart inverter, if the error still exist, contact us (Bus sample)
E031	Internal communication fault4	Restart inverter, if the error still exist, contact us (DSP&M8)

Code	Description	Trouble shooting
W000	Communication failure with battery	Check if you have choose the right battery brand and communication cable is right, if the warning still exist, contact us
W001	Battery temperature high	Check battery temperature sensor is right connected and the battery temperature is not too high
W002	Battery temperature low	Check battery temperature sensor is right connected and the battery temperature is not too low
W004	Battery failure	Inverter get battery fault info from battery BMS, restart battery, if the warning still exist, contact us or battery manufacture
W008	Software mismatch	Please contact Luxpower for firmware update
W009	Fan Stuck	Check if the fan is OK
W012	Bat On Mos	Restart inverter, if the error still exist, contact us
W013	Over temperature	The temperature is a little bit high inside inverter
W018	AC Frequency out of range	Check AC frequency is in range
W025	Battery voltage high	Check if battery voltage is in normal range
W026	Battery voltage low	Check if battery voltage is in normal range, need to charge the battery if battery voltage is low
W027	Battery open	Check if there is output from the battery and battery connection with inverter is OK
W028	EPS Over load	Check if EPS load is too high
W029	EPS voltage high	Restart inverter, if the error still exist, contact us
W031	EPS DCV high	Restart inverter, if the error still exist, contact us